

Rohrventilatoren aus Kunststoff oder Stahl

Tube fans made of plastic or steel



Typenschlüssel / Type Code

Rohrventilator / *tube fan*

Kunststoffgehäuse 8-eckig /
plastic casing 8-angular

Rohrdurchmesser / *duct diameter*

Größerer Antriebsmotor / *larger motor*

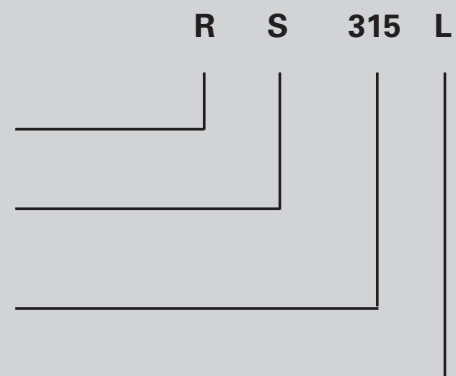

Eigenschaften und Ausführung Stahlrohrventilatoren

Die Größen R100 - R400L haben ein Gehäuse aus verzinktem Stahlblech. Der Antrieb erfolgt durch einen im Radiallaufrad eingebauten Außenläufermotor in Schutzart IP44/54.

Eigenschaften und Ausführung Kunststoffrohrventilatoren

Die Größen RS100L - RS315L haben ein formschönes, schlagfestes, schwer entflammbares Kunststoffgehäuse mit integriertem Klemmkasten in Schutzart IP44 und ein Nachleitwerk. Die Laufräder bis RS315 bestehen aus Kunststoff, RS315L aus verzinktem Stahlblech.

Elektr. Anschluss Stahl- / Kunststoffrohrventilatoren

Die elektrische Ausführung entspricht der VDE0530, Isolationsstoffklasse F mit zusätzlicher Feuchtschutzimprägnierung und eingebautem Thermokontakt, der motorintern mit der Wicklung in Reihe geschaltet ist. Ab der Baugröße 355 sind die Thermokontakte ausgeführt.

Montage Rohrventilatoren

Für die Montage werden starre Wickelfalzrohre (Spiro), flexible Aluminium- oder Kunststoffrohre nach Normdurchmesser eingesetzt.

Luftleistungskennlinien

Die Kennlinien für diese Typenreihe wurden in Einbauart B (frei saugend, druckseitig angeschlossen) aufgenommen und zeigen die Gesamtdruckerhöhung Δp_t als Funktion des Volumenstromes. Der dynamische Druck Δp_{d2} ist auf den Flanschquerschnitt am Ventilatoraustritt bezogen.

Geräusche

In den Luftleistungskennlinien ist der A-bewertete Freiausblas-Schallleistungspegel LWA_6 angegeben (umrandete Zahlen). Die relativen Oktav-Schallleistungspegel LWA_{rel} bei den Oktav-Mittelfrequenzen sind aus den direkt zugeordneten Tabellen der jeweiligen Ventilatorentypen zu entnehmen.

Features and Construction: Steel tube fans

The casings of sizes R100 - R400L are manufactured of galvanized sheet steel. The fans are driven by an external rotor motor, protection class IP44/54, fitted in the centrifugal impeller.

Features and Construction: Plastic tube fans

The sizes RS100L - RS315L are equipped with an attractive, impact strong and hardly inflammable plastic casing with integrated IP44 terminal box and guide vane. The impeller up to RS315 is made of plastic. The impeller of the RS315L is made of galvanized sheet steel.

Electrical Connection: Steel- / Plastic tube fans

Electrical construction is according to VDE0530, insulation class F with additional moisture protection impregnation and thermal contacts which are connected in series with the windings of the motor. From size 355 the thermal contacts are leaded out.

Installation tube fans

Rigid folded spiral-seam ducts (Spiro), flexible aluminium or plastic ducts with standardized diameter can be used.

Air performance curves

The performance curves for these fan types have been measured in mounting position B (installed on the pressure side and open on the suction side) and show the total pressure increase Δp_t as a function of the air flow. The dynamic pressure Δp_{d2} refers to the flange cross section at the outlet side of the fan.

Noise levels

The bordered values printed in the performance curve diagrams show the „A“ weighted LWA_6 sound power level at the outlet side in duct systems. The relative octave sound power level LWA_{rel} at octave medium frequency you can find on the table on each fan type page.



- Gehäuse aus verzinktem Stahlblech
- in allen Einbaulagen einsetzbar
- einfacher elektrischer Anschluss durch außenliegenden Klemmkasten (IP54)
- Isolierstoffklasse F
- Motorschutz durch Thermokontakte
- transformatorisch und elektronisch 100% stufenlos steuerbar
- casing made of galvanized sheet steel
- easy installation in any position
- easy electrical connection via IP54 terminal box
- insulation class F
- motor protection by thermal contacts
- speed is 100% infinitely variable using auto transformers or electronic control

Technische Daten / Technical Data:

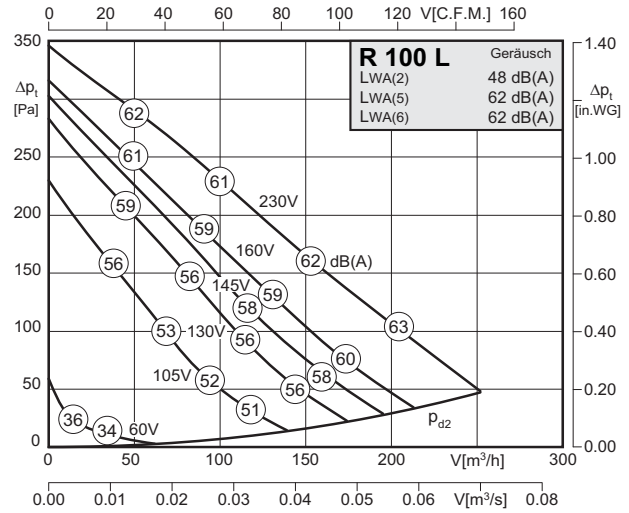
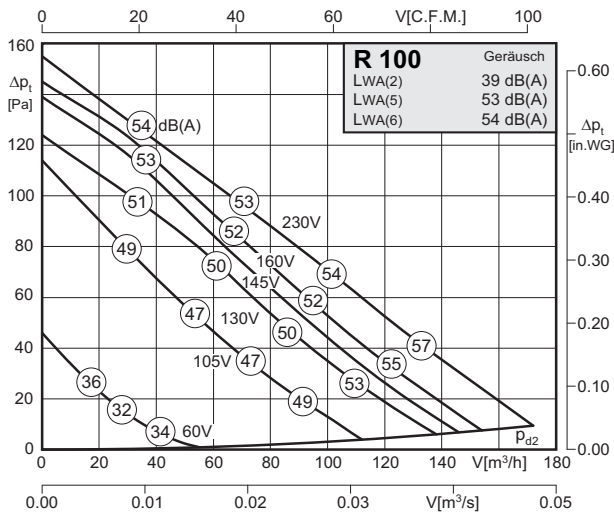

Typ / Type: R 100		Art.-Nr. / Art.-No.: F00-10082	
U	230V (50Hz)	Δp_{fa} min	- Pa
P ₁	0.028 kW	ΔI	- %
I _N	0.12 A	I _A / I _N	1.6
n	2650 min ⁻¹		IP44
C _{400V}	1 μ F		01.009
t _R	70 °C		2.0 kg

Typ / Type: R 100 L		Art.-Nr. / Art.-No.: F00-10087	
U	230V (50Hz)	Δp_{fa} min	- Pa
P ₁	0.065 kW	ΔI	- %
I _N	0.30 A	I _A / I _N	1.5
n	2470 min ⁻¹		IP44
C _{400V}	2 μ F		01.009
t _R	70 °C		2.6 kg

Geräusche / Sound levels:

LWArel A-bewertet bei V=0,5*Vmax LWArel A-weighted at V=0,5*Vmax	fM [Hz]						
	125	250	500	1K	2K	4K	8K
LWA2 [dB(A)] Gehäuse / casing	30	33	32	32	32	23	18
LWA5 [dB(A)] Ansaugseite / inlet side	39	47	48	47	44	35	26
LWA6 [dB(A)] Ausblasseite / outlet side	39	46	49	49	46	38	28

LWArel A-bewertet bei V=0,5*Vmax LWArel A-weighted at V=0,5*Vmax	fM [Hz]						
	125	250	500	1K	2K	4K	8K
LWA2 [dB(A)] Gehäuse / casing	36	42	41	42	41	33	26
LWA5 [dB(A)] Ansaugseite / inlet side	45	53	56	57	54	51	41
LWA6 [dB(A)] Ausblasseite / outlet side	44	54	56	57	55	50	40

Schaltbild / Wiring diagram:

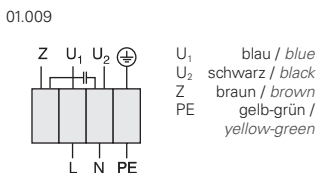

Maße / Dimensions:

(alle Maße in mm / all dimensions in mm)

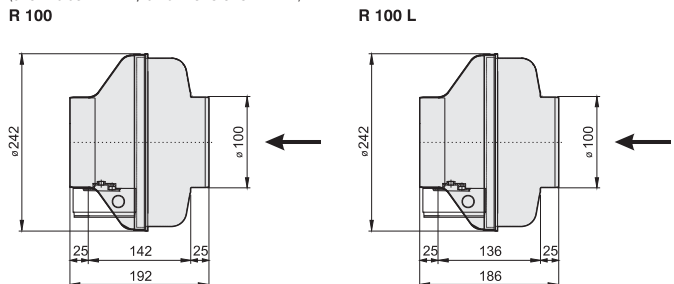

Zubehör / Accessories:





- Gehäuse aus Kunststoff
- extrem geringer Geräuschpegel
- absolut korrosionsbeständig
- einfacher elektrischer Anschluss durch außenliegenden Klemmkasten (IP54)
- Isolierstoffklasse F
- Motorschutz durch Thermokontakte
- transformatorisch und elektronisch 100% stufenlos steuerbar
- casing made of plastic
- lower noise level
- completely corrosion resistant
- easy electrical connection via IP54 terminal box
- insulation class F
- motor protection by thermal contacts
- speed is 100% infinitely variable using auto transformers or electronic control

Technische Daten / Technical Data:

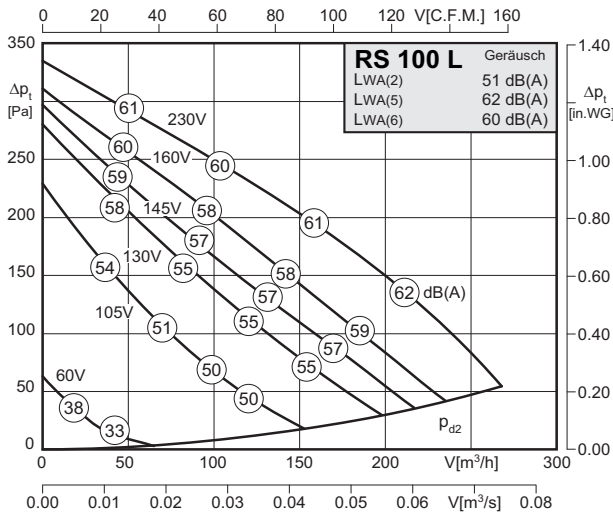

Typ / Type : RS 100 L		Art.-Nr. / Art.-No. : F00-10060	
U	230V (50Hz)	Δp _{fa min}	-- Pa
P ₁	0,065 kW	ΔI	-- %
I _N	0.3 A	I _A / I _N	1.5
n	2480 min ⁻¹	▲	IP44
C _{400V}	2 μF	✳	01.009
t _R	70 °C	■	2.4 kg

Geräusche / Sound levels:

LWA _{rel} A-bewertet bei V=0,5*V _{max} LWA _{rel} A-weighted at V=0,5*V _{max}		fM [Hz]						
		125	250	500	1K	2K	4K	8K
LWA ₂ [dB(A)]	Gehäuse / casing	33	42	44	47	44	38	27
LWA ₅ [dB(A)]	Ansaugseite / inlet side	43	54	57	56	54	51	41
LWA ₆ [dB(A)]	Ausblasseite / outlet side	42	53	54	54	53	49	40

Schaltbild / Wiring diagram:

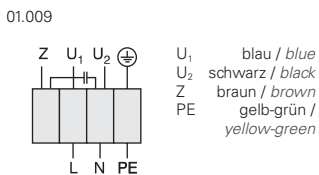

Maße / Dimensions:

(alle Maße in mm / all dimensions in mm)

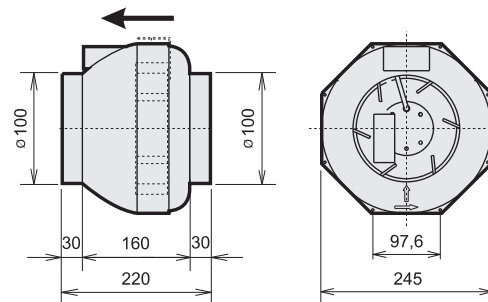

Zubehör / Accessories:





- Gehäuse aus verzinktem Stahlblech
- in allen Einbaulagen einsetzbar
- einfacher elektrischer Anschluss durch außenliegenden Klemmkasten (IP54)
- Isolierstoffklasse F
- Motorschutz durch Thermokontakte
- transformatorisch und elektronisch 100% stufenlos steuerbar
- casing made of galvanized sheet steel
- easy installation in any position
- easy electrical connection via IP54 terminal box
- insulation class F
- motor protection by thermal contacts
- speed is 100% infinitely variable using auto transformers or electronic control

Technische Daten / Technical Data:

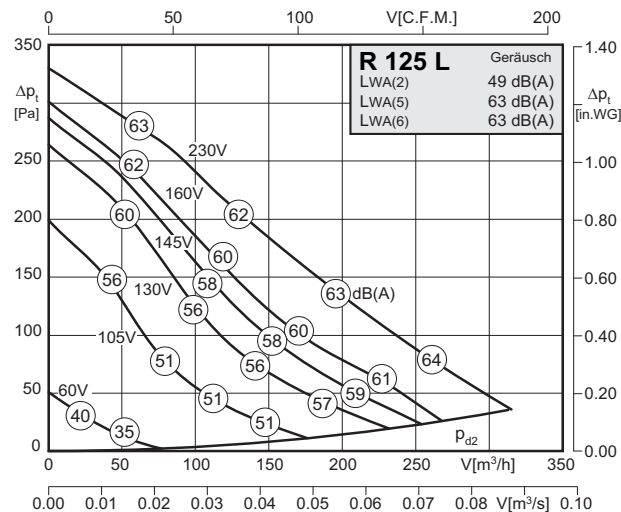
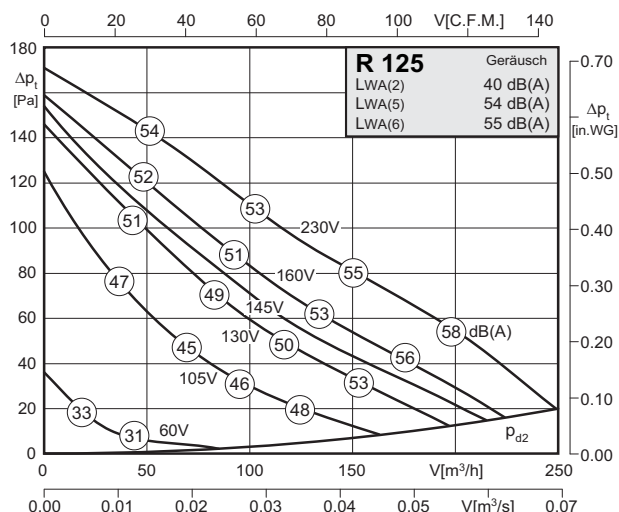

Typ / Type: R 125		Art.-Nr. / Art.-No.: F00-12582	
U	230V (50Hz)	Δp_{fa} min	- Pa
P ₁	0.028 kW	ΔI	- %
I _N	0.12 A	I _A / I _N	1.7
n	2620 min ⁻¹		IP44
C _{400V}	1 μ F		01.009
t _R	70 °C		2.1 kg

Typ / Type: R 125 L		Art.-Nr. / Art.-No.: F00-12587	
U	230V (50Hz)	Δp_{fa} min	- Pa
P ₁	0.065 kW	ΔI	- %
I _N	0.30 A	I _A / I _N	1.5
n	2480 min ⁻¹		IP44
C _{400V}	2 μ F		01.009
t _R	70 °C		2.6 kg

Geräusche / Sound levels:

LWArel A-bewertet bei V=0,5*Vmax LWArel A-weighted at V=0,5*Vmax		fM [Hz]						
		125	250	500	1K	2K	4K	8K
LWA2 [dB(A)]	Gehäuse / casing	31	34	33	32	32	23	18
LWA5 [dB(A)]	Ansaugseite / inlet side	40	48	49	48	45	36	27
LWA6 [dB(A)]	Ausblasseite / outlet side	40	47	50	50	47	39	29

LWArel A-bewertet bei V=0,5*Vmax LWArel A-weighted at V=0,5*Vmax		fM [Hz]						
		125	250	500	1K	2K	4K	8K
LWA2 [dB(A)]	Gehäuse / casing	36	42	42	43	43	36	28
LWA5 [dB(A)]	Ansaugseite / inlet side	48	53	56	59	56	52	43
LWA6 [dB(A)]	Ausblasseite / outlet side	47	55	56	58	56	53	42

Schaltbild / Wiring diagram:

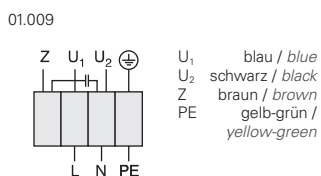

Maße / Dimensions:

(alle Maße in mm / all dimensions in mm)

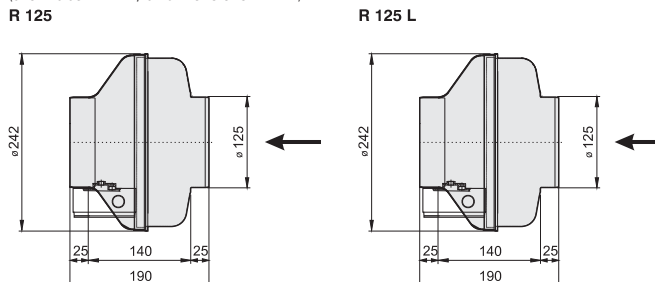

Zubehör / Accessories:





- Gehäuse aus Kunststoff
- extrem geringer Geräuschpegel
- absolut korrosionsbeständig
- einfacher elektrischer Anschluss durch außenliegenden Klemmkasten (IP54)
- Isolierstoffklasse F
- Motorschutz durch Thermokontakte
- transformatorisch und elektronisch 100% stufenlos steuerbar
- casing made of plastic
- lower noise level
- completely corrosion resistant
- easy electrical connection via IP54 terminal box
- insulation class F
- motor protection by thermal contacts
- speed is 100% infinitely variable using auto transformers or electronic control

Technische Daten / Technical Data:

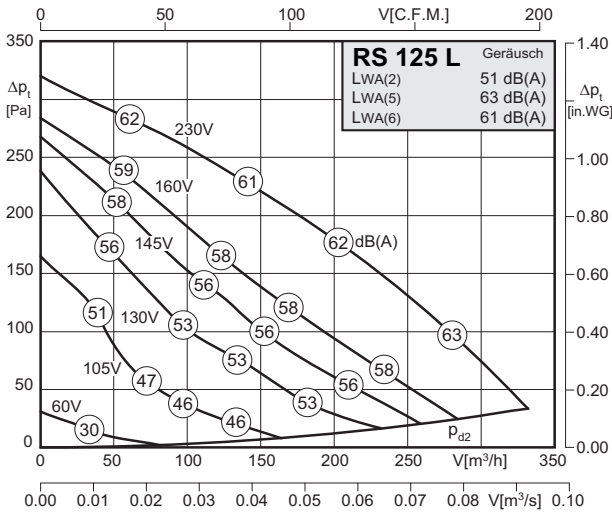

Typ / Type : RS 125 L		Art.-Nr. / Art.-No. : F00-12550	
U	230V (50Hz)	Δp _{fa min}	-- Pa
P ₁	0,065 kW	ΔI	-- %
I _N	0.30 A	I _A / I _N	1.5
n	2415 min ⁻¹	▲	IP44
C _{400V}	2 μF	★	01.009
t _R	70 °C	■	2.4 kg

Geräusche / Sound levels:

LWA _{rel} A-bewertet bei V=0,5*V _{max} LWA _{rel} A-weighted at V=0,5*V _{max}		fM [Hz]						
		125	250	500	1K	2K	4K	8K
LWA ₂ [dB(A)]	Gehäuse / casing	33	42	44	47	44	38	27
LWA ₅ [dB(A)]	Ansaugseite / inlet side	43	55	58	57	56	51	41
LWA ₆ [dB(A)]	Ausblasseite / outlet side	42	53	55	56	54	49	40

Schaltbild / Wiring diagram:

01.009

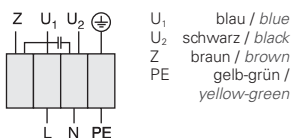

Maße / Dimensions:

(alle Maße in mm / all dimensions in mm)

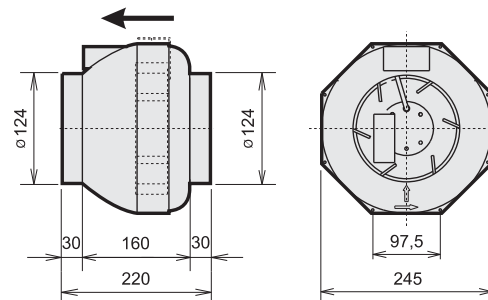

Zubehör / Accessories:





- Gehäuse aus verzinktem Stahlblech
- in allen Einbaulagen einsetzbar
- einfacher elektrischer Anschluss durch außenliegenden Klemmkasten (IP54)
- Isolierstoffklasse F
- Motorschutz durch Thermokontakte
- transformatorisch und elektronisch 100% stufenlos steuerbar
- casing made of galvanized sheet steel
- easy installation in any position
- easy electrical connection via IP54 terminal box
- insulation class F
- motor protection by thermal contacts
- speed is 100% infinitely variable using auto transformers or electronic control

Technische Daten / Technical Data:

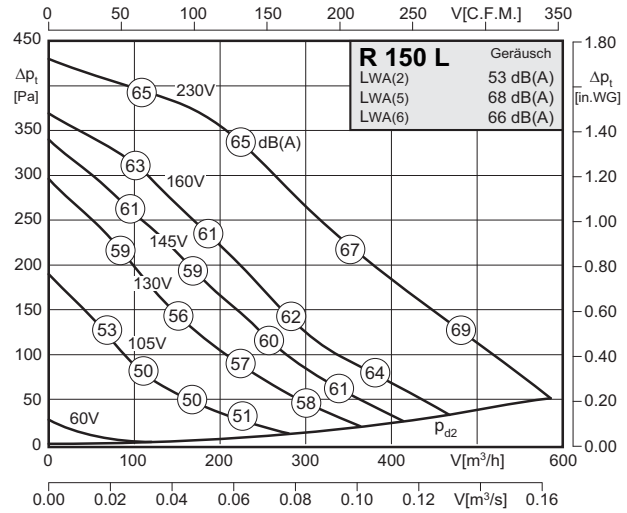
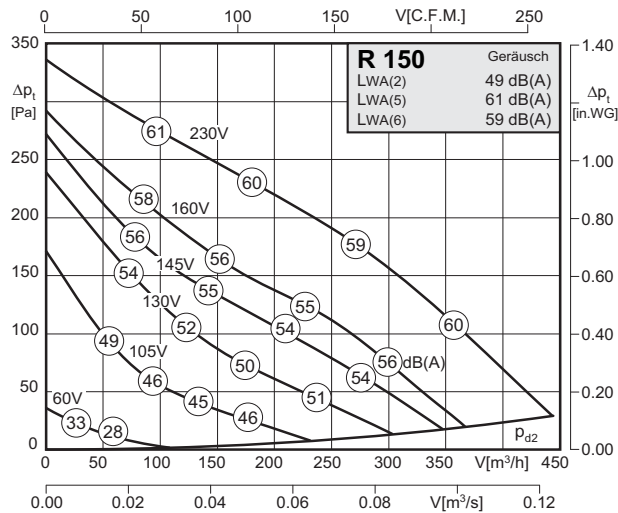

Typ / Type: R 150		Art.-Nr. / Art.-No.: F00-15082	
U	230V (50Hz)	Δp_{fa} min	- Pa
P ₁	0.07 kW	ΔI	- %
I _N	0.3 A	I _A / I _N	1.5
n	2420 min ⁻¹		IP44
C _{400v}	2 μ F		01.009
t _R	70 °C		3.4 kg

Typ / Type: R 150 L		Art.-Nr. / Art.-No.: F00-15087	
U	230V (50Hz)	Δp_{fa} min	- Pa
P ₁	0.11 kW	ΔI	- %
I _N	0.47 A	I _A / I _N	1.5
n	2520 min ⁻¹		IP44
C _{400v}	3 μ F		01.009
t _R	60 °C		3.7 kg

Geräusche / Sound levels:

LWArel A-bewertet bei V=0,5*Vmax LWArel A-weighted at V=0,5*Vmax	fM [Hz]						
	125	250	500	1K	2K	4K	8K
LWA2 [dB(A)] Gehäuse / casing	34	40	44	43	43	33	26
LWA5 [dB(A)] Ansaugseite / inlet side	42	53	55	55	54	51	44
LWA6 [dB(A)] Ausblasseite / outlet side	36	49	50	53	55	50	40

LWArel A-bewertet bei V=0,5*Vmax LWArel A-weighted at V=0,5*Vmax	fM [Hz]						
	125	250	500	1K	2K	4K	8K
LWA2 [dB(A)] Gehäuse / casing	45	47	47	46	43	39	30
LWA5 [dB(A)] Ansaugseite / inlet side	51	59	63	62	62	54	46
LWA6 [dB(A)] Ausblasseite / outlet side	51	59	59	61	59	53	44

Schaltbild / Wiring diagram:

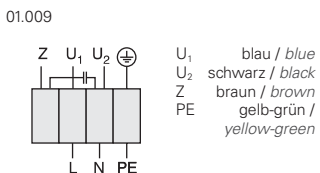

Maße / Dimensions:

(alle Maße in mm / all dimensions in mm)
R 150

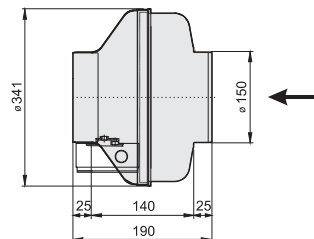

R 150 L

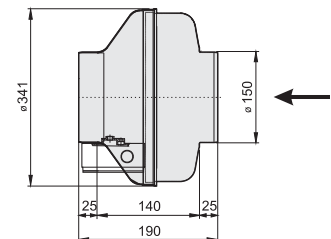

Zubehör / Accessories:





- Gehäuse aus Kunststoff
- extrem geringer Geräuschpegel
- absolut korrosionsbeständig
- einfacher elektrischer Anschluss durch außenliegenden Klemmkasten (IP54)
- Isolierstoffklasse F
- Motorschutz durch Thermokontakte
- transformatorisch und elektronisch 100% stufenlos steuerbar
- casing made of plastic
- lower noise level
- completely corrosion resistant
- easy electrical connection via IP54 terminal box
- insulation class F
- motor protection by thermal contacts
- speed is 100% infinitely variable using auto transformers or electronic control

Technische Daten / Technical Data:

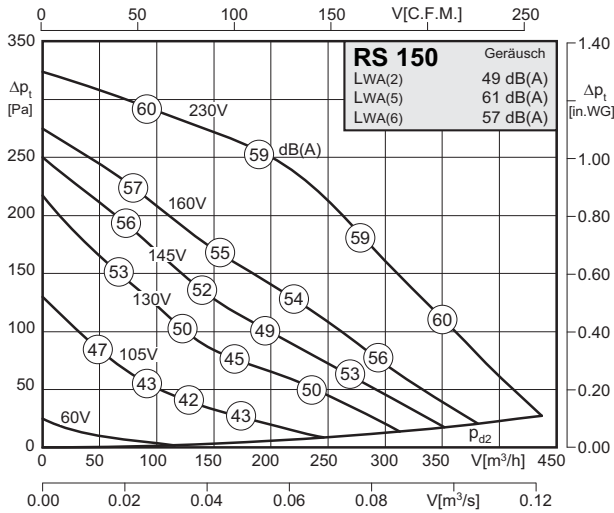

Typ / Type : RS 150		Art.-Nr. / Art.-No. : F00-15050	
U	230V (50Hz)	Δpfa min	-- Pa
P1	0,07 kW	ΔI	-- %
IN	0.30 A	IA / IN	1.5
n	2400 min-1	▲	IP44
C400V	2 μF	★	01.009
tR	70 °C	■	3.0 kg

Geräusche / Sound levels:

LWArel A-bewertet bei V=0,5*Vmax LWArel A-weighted at V=0,5*Vmax		fM [Hz]						
		125	250	500	1K	2K	4K	8K
LWA2 [dB(A)]	Gehäuse / casing	33	40	43	43	44	32	23
LWA5 [dB(A)]	Ansaugseite / inlet side	40	54	55	55	54	50	41
LWA6 [dB(A)]	Ausblasseite / outlet side	37	49	47	51	52	49	39

Schaltbild / Wiring diagram:

01.009

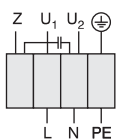

U₁ blau / blue
U₂ schwarz / black
Z braun / brown
PE gelb-grün / yellow-green

Maße / Dimensions:

(alle Maße in mm / all dimensions in mm)

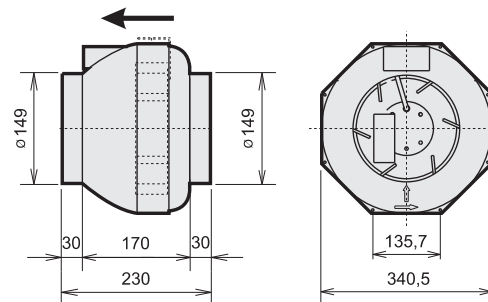

Zubehör / Accessories:



RE	ED	TE	GS	VBM	RSK	VK	HB	TFB	RSD	BG
Seite/Page 382	Seite/Page 402	Seite/Page 400	Seite/Page 404	Seite/Page 420	Seite/Page 420	Seite/Page 420	Seite/Page 421	Seite/Page 422	Seite/Page 422	Seite/Page 423



- Gehäuse aus verzinktem Stahlblech
- in allen Einbaulagen einsetzbar
- einfacher elektrischer Anschluss durch außenliegenden Klemmkasten (IP54)
- Isolierstoffklasse F
- Motorschutz durch Thermokontakte
- transformatorisch und elektronisch 100% stufenlos steuerbar
- casing made of galvanized sheet steel
- easy installation in any position
- easy electrical connection via IP54 terminal box
- insulation class F
- motor protection by thermal contacts
- speed is 100% infinitely variable using auto transformers or electronic control

Technische Daten / Technical Data:

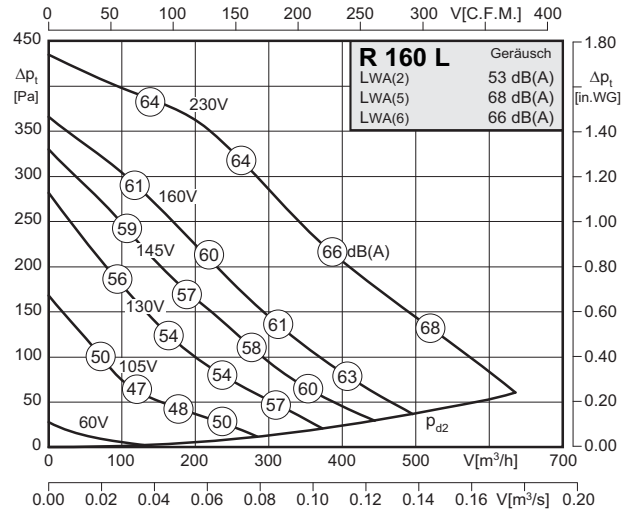
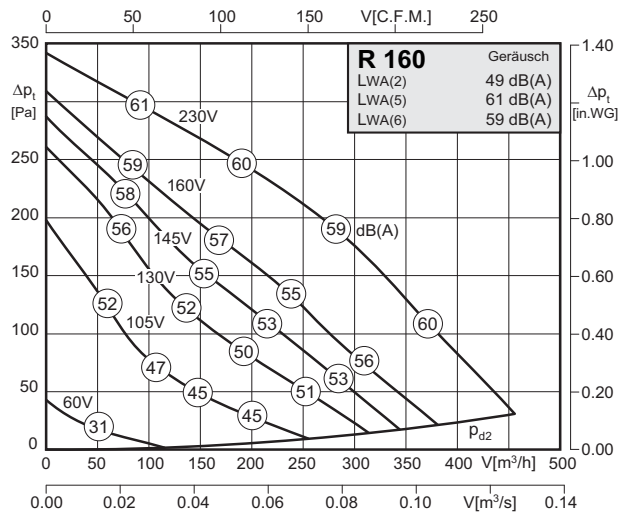

Typ / Type: R 160		Art.-Nr. / Art.-No.: F00-16082	
U	230V (50Hz)	$\Delta p_{fa \text{ min}}$	- Pa
P ₁	0.07 kW	ΔI	- %
I _N	0.3 A	I _A / I _N	1.5
n	2380 min ⁻¹		IP44
C _{400v}	2 μ F		01.009
t _R	70 °C		3.4 kg

Typ / Type: R 160 L		Art.-Nr. / Art.-No.: F00-16087	
U	230V (50Hz)	$\Delta p_{fa \text{ min}}$	- Pa
P ₁	0.11 kW	ΔI	- %
I _N	0.47 A	I _A / I _N	1.5
n	2500 min ⁻¹		IP44
C _{400v}	3 μ F		01.009
t _R	60 °C		3.4 kg

Geräusche / Sound levels:

LWArel A-bewertet bei V=0,5*Vmax LWArel A-weighted at V=0,5*Vmax		fM [Hz]						
		125	250	500	1K	2K	4K	8K
LWA2 [dB(A)]	Gehäuse / casing	34	40	44	43	43	33	26
LWA5 [dB(A)]	Ansaugseite / inlet side	42	53	55	55	54	51	44
LWA6 [dB(A)]	Ausblasseite / outlet side	36	49	50	53	55	50	40

LWArel A-bewertet bei V=0,5*Vmax LWArel A-weighted at V=0,5*Vmax		fM [Hz]						
		125	250	500	1K	2K	4K	8K
LWA2 [dB(A)]	Gehäuse / casing	45	47	47	46	43	39	30
LWA5 [dB(A)]	Ansaugseite / inlet side	51	59	63	62	62	54	46
LWA6 [dB(A)]	Ausblasseite / outlet side	51	59	59	61	59	53	44

Schaltbild / Wiring diagram:

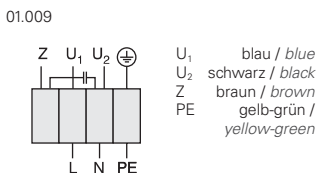

Maße / Dimensions:

(alle Maße in mm / all dimensions in mm)
R 160

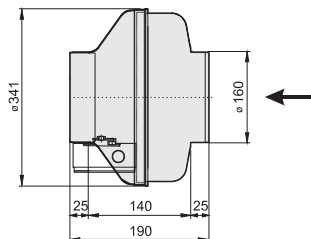

R 160 L

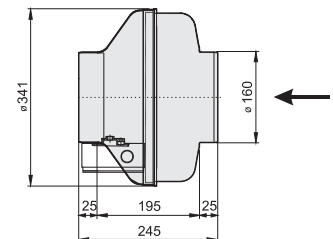

Zubehör / Accessories:





- Gehäuse aus Kunststoff
- extrem geringer Geräuschpegel
- absolut korrosionsbeständig
- einfacher elektrischer Anschluss durch außenliegenden Klemmkasten (IP54)
- Isolierstoffklasse F
- Motorschutz durch Thermokontakte
- transformatorisch und elektronisch 100% stufenlos steuerbar
- casing made of plastic
- lower noise level
- completely corrosion resistant
- easy electrical connection via IP54 terminal box
- insulation class F
- motor protection by thermal contacts
- speed is 100% infinitely variable using auto transformers or electronic control

Technische Daten / Technical Data:

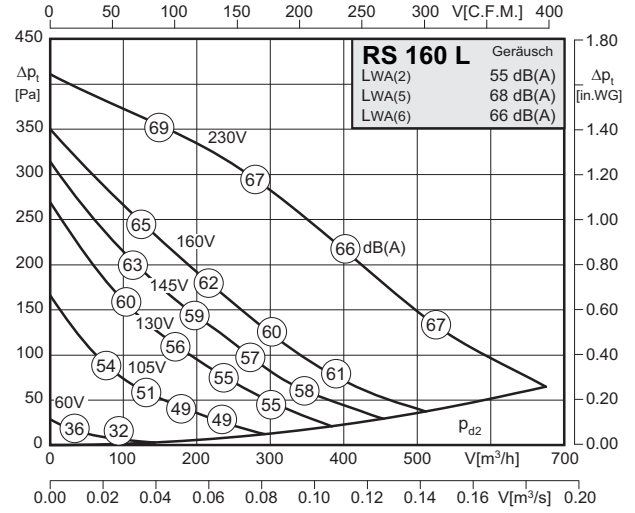
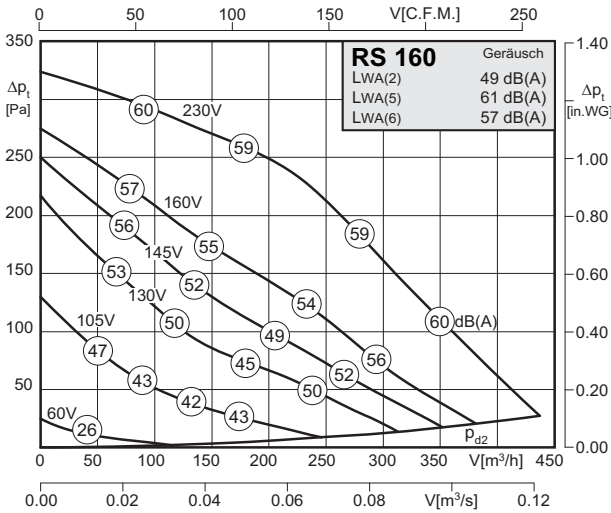

Typ / Type : RS 160		Art.-Nr. / Art.-No. : F00-16051	
U	230V (50Hz)	$\Delta p_{fa \text{ min}}$	-- Pa
P ₁	0,07 kW	ΔI	-- %
I _N	0.30 A	I _A / I _N	1.5
n	2400 min ⁻¹		IP44
C _{400v}	2 μ F		01.009
t _R	70 °C		3.0 kg

Typ / Type : RS 160 L		Art.-Nr. / Art.-No. : F00-16060	
U	230V (50Hz)	$\Delta p_{fa \text{ min}}$	-- Pa
P ₁	0,115 kW	ΔI	-- %
I _N	0.49 A	I _A / I _N	1.5
n	2440 min ⁻¹		IP44
C _{400v}	3 μ F		01.009
t _R	50 °C		3.2 kg

Geräusche / Sound levels:

LWA _{rel} A-bewertet bei V=0,5*V _{max} LWA _{rel} A-weighted at V=0,5*V _{max}		fM [Hz]						
		125	250	500	1K	2K	4K	8K
LWA2 [dB(A)]	Gehäuse / casing	33	40	43	43	44	32	23
LWA5 [dB(A)]	Ansaugseite / inlet side	40	54	55	55	54	50	41
LWA6 [dB(A)]	Ausblasseite / outlet side	37	49	47	51	52	49	39

LWA _{rel} A-bewertet bei V=0,5*V _{max} LWA _{rel} A-weighted at V=0,5*V _{max}		fM [Hz]						
		125	250	500	1K	2K	4K	8K
LWA2 [dB(A)]	Gehäuse / casing	41	43	51	50	47	39	30
LWA5 [dB(A)]	Ansaugseite / inlet side	45	58	61	63	62	59	50
LWA6 [dB(A)]	Ausblasseite / outlet side	43	55	55	60	62	58	50

Schaltbild / Wiring diagram:

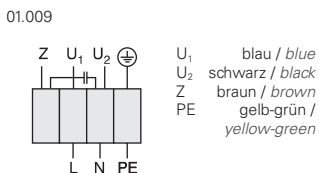

Maße / Dimensions:

(alle Maße in mm / all dimensions in mm)

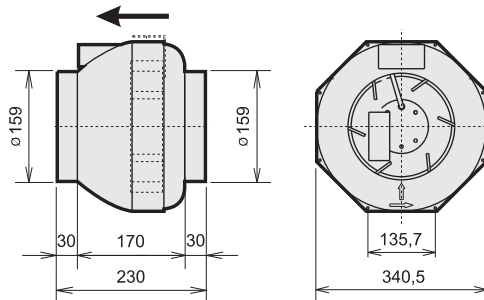

Zubehör / Accessories:





- Gehäuse aus verzinktem Stahlblech
- in allen Einbaulagen einsetzbar
- einfacher elektrischer Anschluss durch außenliegenden Klemmkasten (IP54)
- Isolierstoffklasse F
- Motorschutz durch Thermokontakte
- transformatorisch und elektronisch 100% stufenlos steuerbar
- casing made of galvanized sheet steel
- easy installation in any position
- easy electrical connection via IP54 terminal box
- insulation class F
- motor protection by thermal contacts
- speed is 100% infinitely variable using auto transformers or electronic control

Technische Daten / Technical Data:

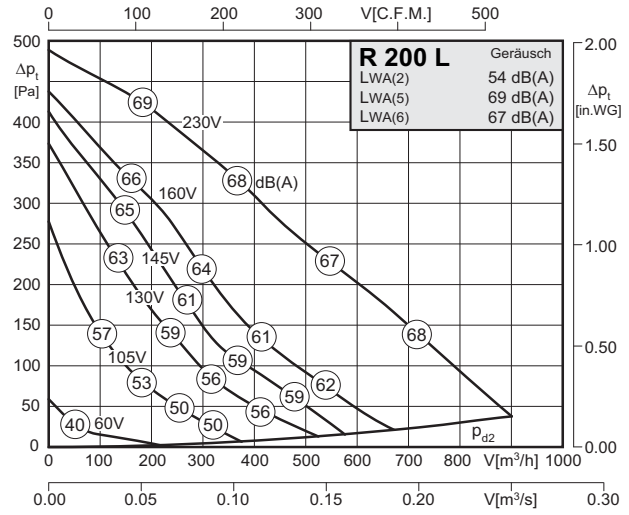
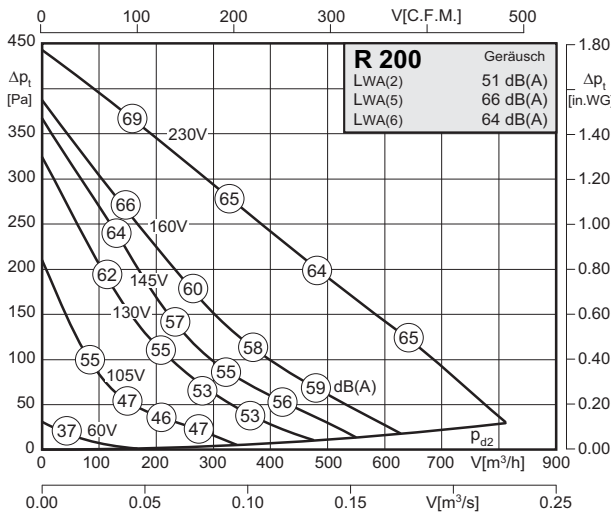

Typ / Type: R 200		Art.-Nr. / Art.-No.: F00-20082	
U	230V (50Hz)	$\Delta p_{fa \text{ min}}$	- Pa
P ₁	0.12 kW	ΔI	- %
I _N	0.5 A	I _A / I _N	1.5
n	2430 min ⁻¹		IP44
C _{400V}	3 μ F		01.009
t _R	70 °C		3.7 kg

Typ / Type: R 200 L		Art.-Nr. / Art.-No.: F00-20087	
U	230V (50Hz)	$\Delta p_{fa \text{ min}}$	- Pa
P ₁	0.17 kW	ΔI	8 %
I _N	0.73 A	I _A / I _N	1.6
n	2410 min ⁻¹		IP44
C _{400V}	5 μ F		01.009
t _R	65 °C		4.2 kg

Geräusche / Sound levels:

LWArel A-bewertet bei V=0,5*Vmax LWArel A-weighted at V=0,5*Vmax	fM [Hz]						
	125	250	500	1K	2K	4K	8K
LWA2 [dB(A)] Gehäuse / casing	37	45	44	45	45	37	28
LWA5 [dB(A)] Ansaugseite / inlet side	44	57	59	60	61	56	47
LWA6 [dB(A)] Ausblasseite / outlet side	42	53	53	59	60	54	47

LWArel A-bewertet bei V=0,5*Vmax LWArel A-weighted at V=0,5*Vmax	fM [Hz]						
	125	250	500	1K	2K	4K	8K
LWA2 [dB(A)] Gehäuse / casing	42	49	48	49	46	40	32
LWA5 [dB(A)] Ansaugseite / inlet side	50	61	63	64	62	57	50
LWA6 [dB(A)] Ausblasseite / outlet side	47	57	58	62	62	57	50

Schaltbild / Wiring diagram:

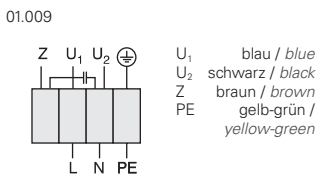

Maße / Dimensions:

(alle Maße in mm / all dimensions in mm)
R 200

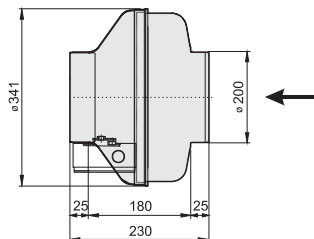

R 200 L

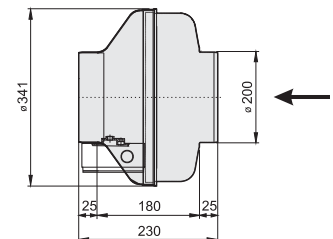

Zubehör / Accessories:





- Gehäuse aus Kunststoff
- extrem geringer Geräuschpegel
- absolut korrosionsbeständig
- einfacher elektrischer Anschluss durch außenliegenden Klemmkasten (IP54)
- Isolierstoffklasse F
- Motorschutz durch Thermokontakte
- transformatorisch und elektronisch 100% stufenlos steuerbar
- casing made of plastic
- lower noise level
- completely corrosion resistant
- easy electrical connection via IP54 terminal box
- insulation class F
- motor protection by thermal contacts
- speed is 100% infinitely variable using auto transformers or electronic control

Technische Daten / Technical Data:

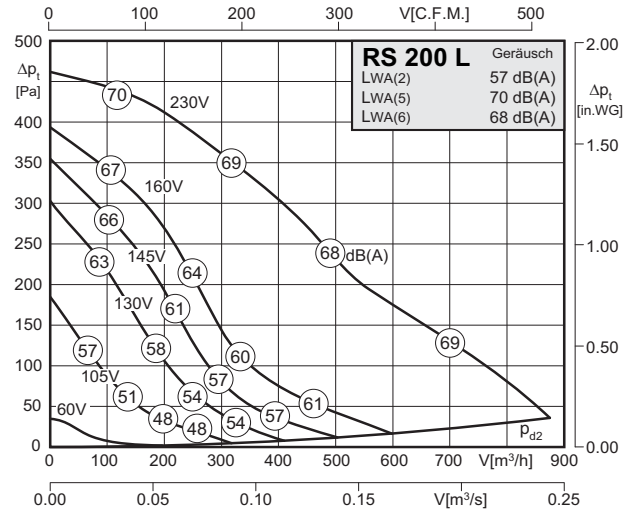
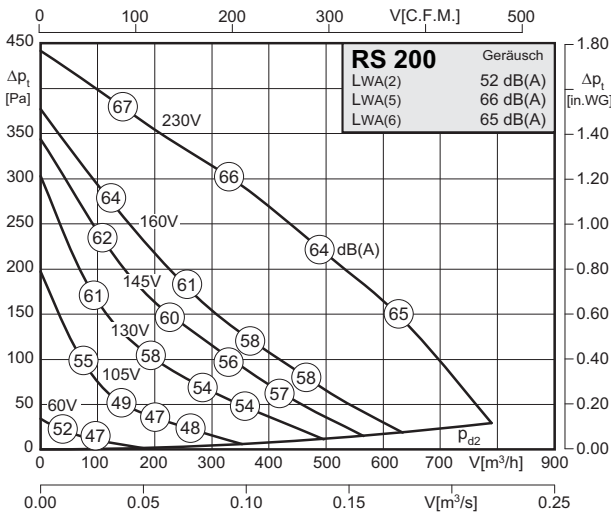

Typ / Type: RS 200		Art.-Nr. / Art.-No.: F00-20051	
U	230V (50Hz)	Δpfa min	-- Pa
P1	0,115 kW	ΔI	2 %
IN	0.50 A	IA / IN	1.5
n	2395 min-1	▲	IP44
C400v	3 μF	✱	01.009
tR	50 °C	■	3.4 kg

Typ / Type: RS 200 L		Art.-Nr. / Art.-No.: F00-20060	
U	230V (50Hz)	Δpfa min	-- Pa
P1	0,160 kW	ΔI	9 %
IN	0.70 A	IA / IN	1.7
n	2540 min-1	▲	IP44
C400v	5 μF	✱	01.009
tR	55 °C	■	3.7 kg

Geräusche / Sound levels:

LWArel A-bewertet bei V=0,5*Vmax LWArel A-weighted at V=0,5*Vmax		fM [Hz]						
		125	250	500	1K	2K	4K	8K
LWA2 [dB(A)]	Gehäuse / casing	38	45	45	46	46	40	30
LWA5 [dB(A)]	Ansaugseite / inlet side	45	56	59	61	61	56	46
LWA6 [dB(A)]	Ausblasseite / outlet side	45	56	54	59	61	56	47

LWArel A-bewertet bei V=0,5*Vmax LWArel A-weighted at V=0,5*Vmax		fM [Hz]						
		125	250	500	1K	2K	4K	8K
LWA2 [dB(A)]	Gehäuse / casing	41	46	54	51	48	41	31
LWA5 [dB(A)]	Ansaugseite / inlet side	50	60	65	64	64	59	49
LWA6 [dB(A)]	Ausblasseite / outlet side	50	59	58	62	64	58	49

Schaltbild / Wiring diagram:

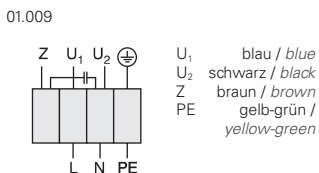

Maße / Dimensions:

(alle Maße in mm / all dimensions in mm)

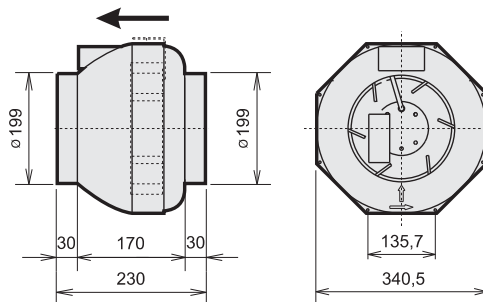

Zubehör / Accessories:





- Gehäuse aus verzinktem Stahlblech
- in allen Einbaulagen einsetzbar
- einfacher elektrischer Anschluss durch außenliegenden Klemmkasten (IP54)
- Isolierstoffklasse F
- Motorschutz durch Thermokontakte
- transformatorisch und elektronisch 100% stufenlos steuerbar
- casing made of galvanized sheet steel
- easy installation in any position
- easy electrical connection via IP54 terminal box
- insulation class F
- motor protection by thermal contacts
- speed is 100% infinitely variable using auto transformers or electronic control

Technische Daten / Technical Data:

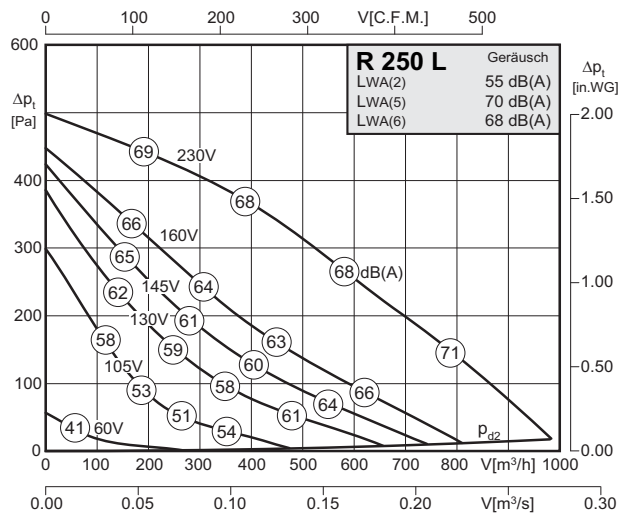
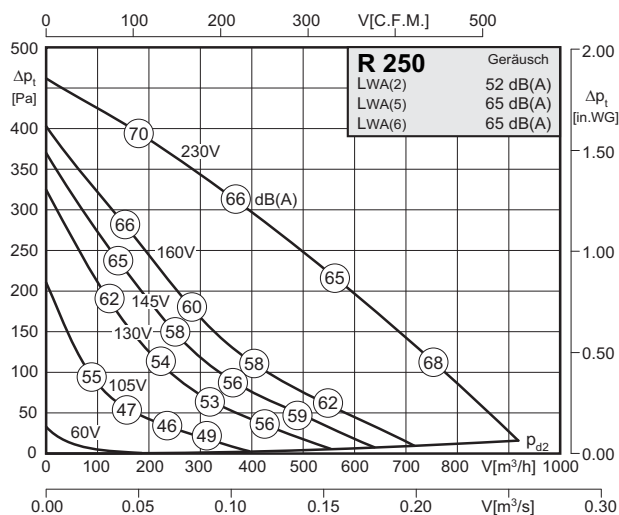

Typ / Type: R 250		Art.-Nr. / Art.-No.: F00-25082	
U	230V (50Hz)	$\Delta p_{fa \text{ min}}$	- Pa
P ₁	0.12 kW	Δi	- %
I _N	0.5 A	I _A / I _N	1.5
n	2400 min ⁻¹		IP44
C _{400v}	3 μ F		01.009
t _R	70 °C		3.7 kg

Typ / Type: R 250 L		Art.-Nr. / Art.-No.: F00-25087	
U	230V (50Hz)	$\Delta p_{fa \text{ min}}$	- Pa
P ₁	0.165 kW	Δi	10 %
I _N	0.70 A	I _A / I _N	1.6
n	2470 min ⁻¹		IP44
C _{400v}	5 μ F		01.009
t _R	60 °C		5.5 kg

Geräusche / Sound levels:

LWArel A-bewertet bei V=0,5*Vmax LWArel A-weighted at V=0,5*Vmax	fM [Hz]						
	125	250	500	1K	2K	4K	8K
LWA2 [dB(A)] Gehäuse / casing	40	47	45	47	41	36	27
LWA5 [dB(A)] Ansaugseite / inlet side	44	55	59	59	60	53	46
LWA6 [dB(A)] Ausblasseite / outlet side	45	56	58	59	60	55	47

LWArel A-bewertet bei V=0,5*Vmax LWArel A-weighted at V=0,5*Vmax	fM [Hz]						
	125	250	500	1K	2K	4K	8K
LWA2 [dB(A)] Gehäuse / casing	43	45	47	51	48	44	34
LWA5 [dB(A)] Ansaugseite / inlet side	48	59	65	65	63	58	49
LWA6 [dB(A)] Ausblasseite / outlet side	49	59	59	63	63	58	49

Schaltbild / Wiring diagram:

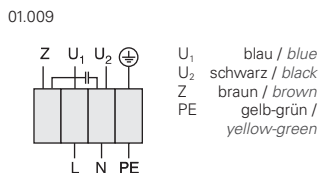

Maße / Dimensions:

(alle Maße in mm / all dimensions in mm)

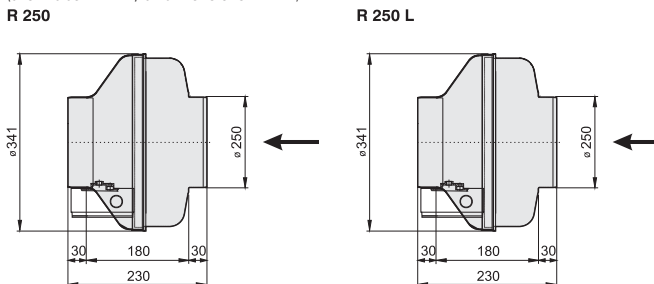

Zubehör / Accessories:





- Gehäuse aus Kunststoff
- extrem geringer Geräuschpegel
- absolut korrosionsbeständig
- einfacher elektrischer Anschluss durch außenliegenden Klemmkasten (IP54)
- Isolierstoffklasse F
- Motorschutz durch Thermokontakte
- transformatorisch und elektronisch 100% stufenlos steuerbar
- casing made of plastic
- lower noise level
- completely corrosion resistant
- easy electrical connection via IP54 terminal box
- insulation class F
- motor protection by thermal contacts
- speed is 100% infinitely variable using auto transformers or electronic control

Technische Daten / Technical Data:

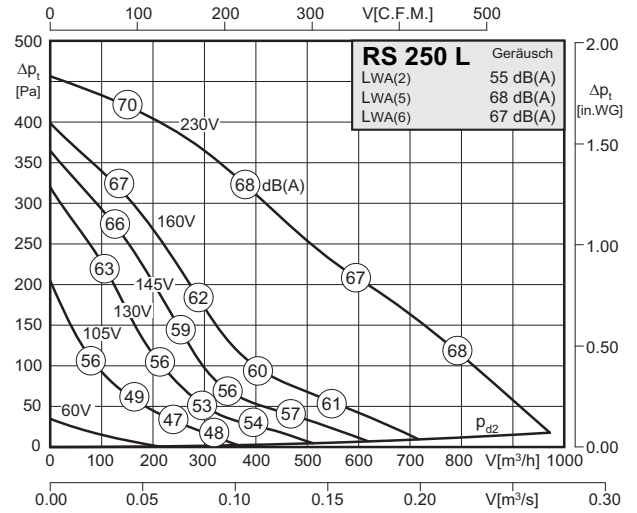
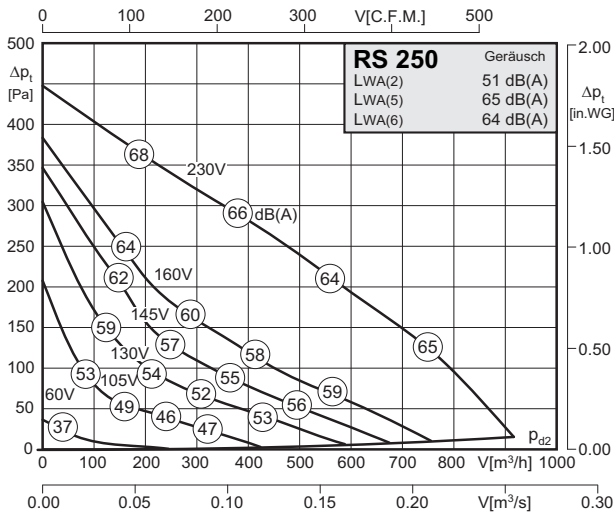

Typ / Type: RS 250		Art.-Nr. / Art.-No.: F00-25051	
U	230V (50Hz)	$\Delta p_{fa \text{ min}}$	-- Pa
P ₁	0,115 kW	ΔI	-- %
I _N	0.50 A	I _A / I _N	1.5
n	2450 min ⁻¹		IP44
C _{400v}	3 μ F		01.009
t _R	50 °C		3.4 kg

Typ / Type: RS 250 L		Art.-Nr. / Art.-No.: F00-25060	
U	230V (50Hz)	$\Delta p_{fa \text{ min}}$	-- Pa
P ₁	0,160 kW	ΔI	14 %
I _N	0.65 A	I _A / I _N	1.8
n	2560 min ⁻¹		IP44
C _{400v}	5 μ F		01.009
t _R	55 °C		3.7 kg

Geräusche / Sound levels:

LWArel A-bewertet bei V=0,5*Vmax LWArel A-weighted at V=0,5*Vmax	fM [Hz]	fM [Hz]						
		125	250	500	1K	2K	4K	8K
LWA2 [dB(A)] Gehäuse / casing		37	44	44	45	45	39	29
LWA5 [dB(A)] Ansaugseite / inlet side		45	55	58	60	60	55	45
LWA6 [dB(A)] Ausblasseite / outlet side		44	55	53	58	60	55	46

LWArel A-bewertet bei V=0,5*Vmax LWArel A-weighted at V=0,5*Vmax	fM [Hz]	fM [Hz]						
		125	250	500	1K	2K	4K	8K
LWA2 [dB(A)] Gehäuse / casing		40	45	52	48	46	40	31
LWA5 [dB(A)] Ansaugseite / inlet side		50	60	61	63	61	58	47
LWA6 [dB(A)] Ausblasseite / outlet side		49	58	58	62	62	57	47

Schaltbild / Wiring diagram:

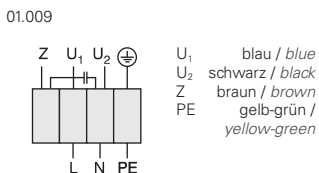

Maße / Dimensions:

(alle Maße in mm / all dimensions in mm)

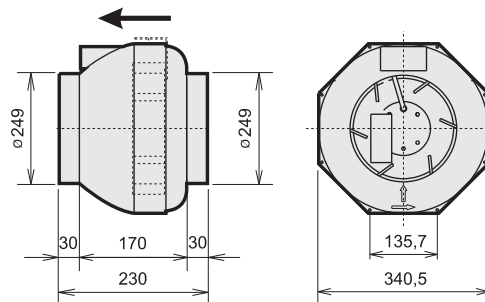

Zubehör / Accessories:





- Gehäuse aus verzinktem Stahlblech
- in allen Einbaulagen einsetzbar
- einfacher elektrischer Anschluss durch außenliegenden Klemmkasten (IP54)
- Isolierstoffklasse F
- Motorschutz durch Thermokontakte
- transformatorisch und elektronisch 100% stufenlos steuerbar
- casing made of galvanized sheet steel
- easy installation in any position
- easy electrical connection via IP54 terminal box
- insulation class F
- motor protection by thermal contacts
- speed is 100% infinitely variable using auto transformers or electronic control

Technische Daten / Technical Data:

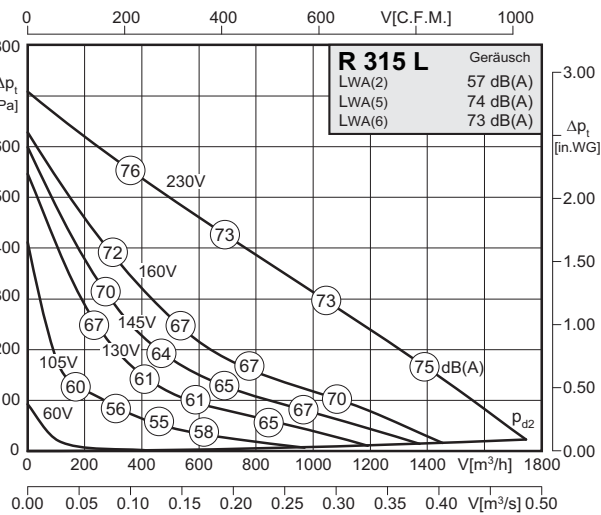
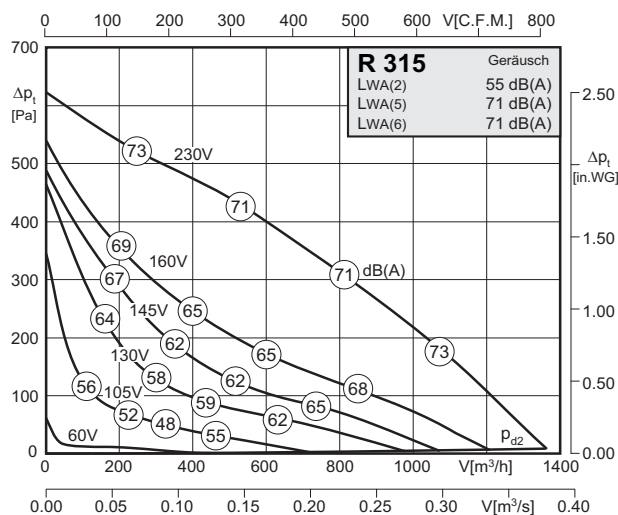

Typ / Type: R 315		Art.-Nr. / Art.-No.: F00-31582	
U	230V (50Hz)	Δp_{fa} min	- Pa
P ₁	0.23 kW	ΔI	10 %
I _N	1.0 A	I _A / I _N	1.8
n	2540 min ⁻¹		IP54
C _{400v}	5 μ F		01.009
t _R	60 °C		6.0 kg

Typ / Type: R 315 L		Art.-Nr. / Art.-No.: F00-31587	
U	230V (50Hz)	Δp_{fa} min	- Pa
P ₁	0.3 kW	ΔI	- %
I _N	1.30 A	I _A / I _N	1.7
n	2440 min ⁻¹		IP44
C _{400v}	8 μ F		01.009
t _R	45 °C		6.0 kg

Geräusche / Sound levels:

LWArel A-bewertet bei V=0,5*Vmax LWArel A-weighted at V=0,5*Vmax	fM [Hz]						
	125	250	500	1K	2K	4K	8K
LWA2 [dB(A)] Gehäuse / casing	42	46	49	50	48	43	34
LWA5 [dB(A)] Ansaugseite / inlet side	48	58	65	66	65	61	56
LWA6 [dB(A)] Ausblasseite / outlet side	54	59	61	66	66	63	56

LWArel A-bewertet bei V=0,5*Vmax LWArel A-weighted at V=0,5*Vmax	fM [Hz]						
	125	250	500	1K	2K	4K	8K
LWA2 [dB(A)] Gehäuse / casing	41	49	51	51	50	47	38
LWA5 [dB(A)] Ansaugseite / inlet side	47	59	68	69	67	66	61
LWA6 [dB(A)] Ausblasseite / outlet side	46	58	62	68	68	65	63

Schaltbild / Wiring diagram:

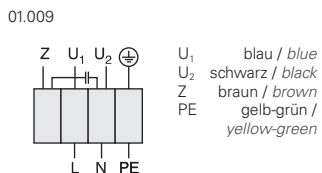

Maße / Dimensions:

(alle Maße in mm / all dimensions in mm)

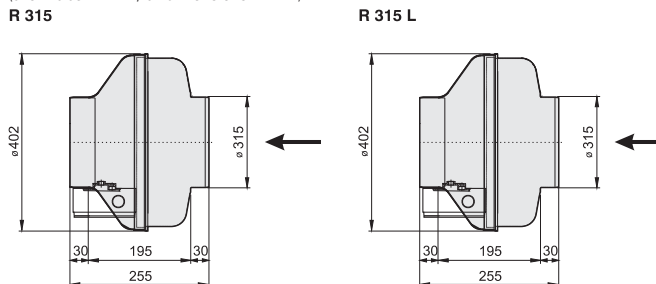

Zubehör / Accessories:





- Gehäuse aus Kunststoff
- extrem geringer Geräuschpegel
- absolut korrosionsbeständig
- einfacher elektrischer Anschluss durch außenliegenden Klemmkasten (IP54)
- Isolierstoffklasse F
- Motorschutz durch Thermokontakte
- transformatorisch und elektronisch 100% stufenlos steuerbar
- casing made of plastic
- lower noise level
- completely corrosion resistant
- easy electrical connection via IP54 terminal box
- insulation class F
- motor protection by thermal contacts
- speed is 100% infinitely variable using auto transformers or electronic control

Technische Daten / Technical Data:

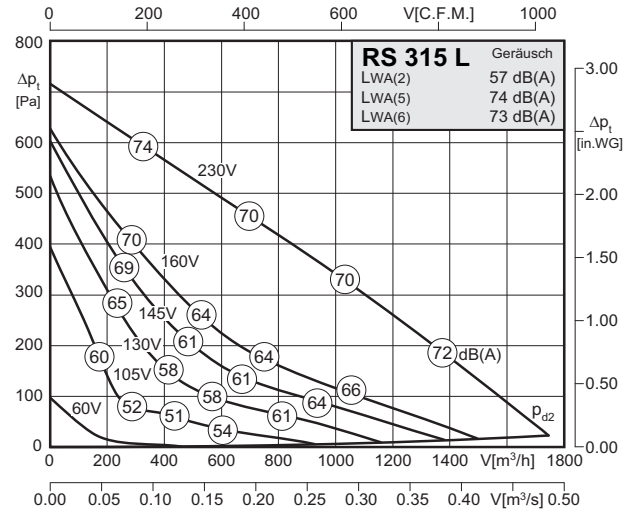
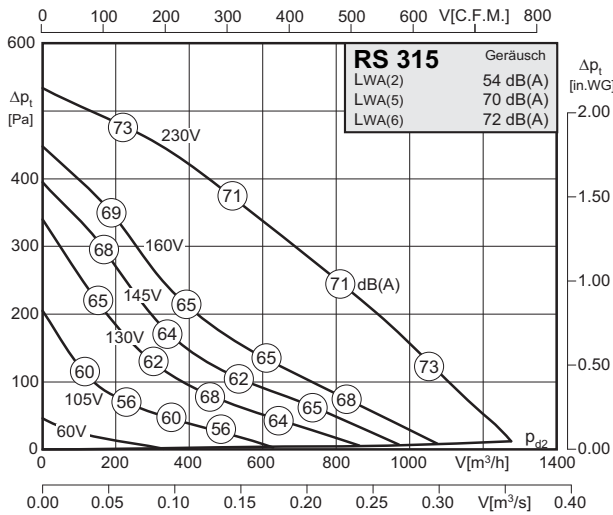

Typ / Type: RS 315		Art.-Nr. / Art.-No.: F00-31551	
U	230V (50Hz)	Δp_{fa} min	-- Pa
P ₁	0,22 kW	ΔI	14 %
I _N	0,95 A	I _A / I _N	1,9
n	2540 min ⁻¹		IP44
C _{400v}	5 μ F		01.009
t _R	55 °C		5,7 kg

Typ / Type: RS 315 L		Art.-Nr. / Art.-No.: F00-31560	
U	230V (50Hz)	Δp_{fa} min	-- Pa
P ₁	0,30 kW	ΔI	-- %
I _N	1,30 A	I _A / I _N	1,7
n	2390 min ⁻¹		IP44
C _{400v}	8 μ F		01.009
t _R	45 °C		5,8 kg

Geräusche / Sound levels:

LWA _{rel} A-bewertet bei V=0,5*V _{max} LWA _{rel} A-weighted at V=0,5*V _{max}		fM [Hz]						
		125	250	500	1K	2K	4K	8K
LWA2 [dB(A)]	Gehäuse / casing	43	46	48	48	47	41	28
LWA5 [dB(A)]	Ansaugseite / inlet side	50	59	64	64	63	62	55
LWA6 [dB(A)]	Ausblasseite / outlet side	51	60	62	65	68	65	58

LWA _{rel} A-bewertet bei V=0,5*V _{max} LWA _{rel} A-weighted at V=0,5*V _{max}		fM [Hz]						
		125	250	500	1K	2K	4K	8K
LWA2 [dB(A)]	Gehäuse / casing	41	49	51	51	50	47	38
LWA5 [dB(A)]	Ansaugseite / inlet side	47	59	68	69	67	66	61
LWA6 [dB(A)]	Ausblasseite / outlet side	43	55	62	63	64	60	57

Schaltbild / Wiring diagram:

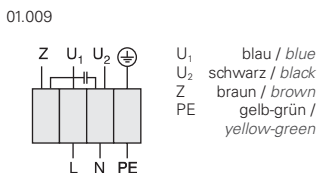

Maße / Dimensions:

(alle Maße in mm / all dimensions in mm)

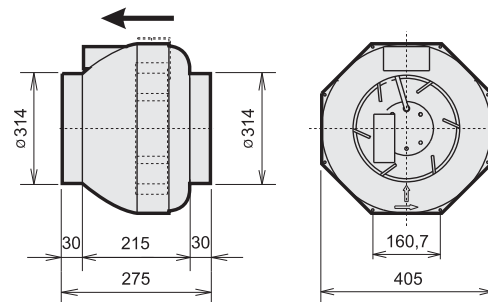

Zubehör / Accessories:





- Gehäuse aus verzinktem Stahlblech
 - in allen Einbaulagen einsetzbar
 - einfacher elektrischer Anschluss durch außenliegenden Klemmkasten (IP54)
 - Isolierstoffklasse F
 - Motorschutz durch Thermokontakte
 - transformatorisch und elektronisch 100% stufenlos steuerbar
- casing made of galvanized sheet steel
 - easy installation in any position
 - easy electrical connection via IP54 terminal box
 - insulation class F
 - motor protection by thermal contacts
 - speed is 100% infinitely variable using auto transformers or electronic control

Technische Daten / Technical Data:

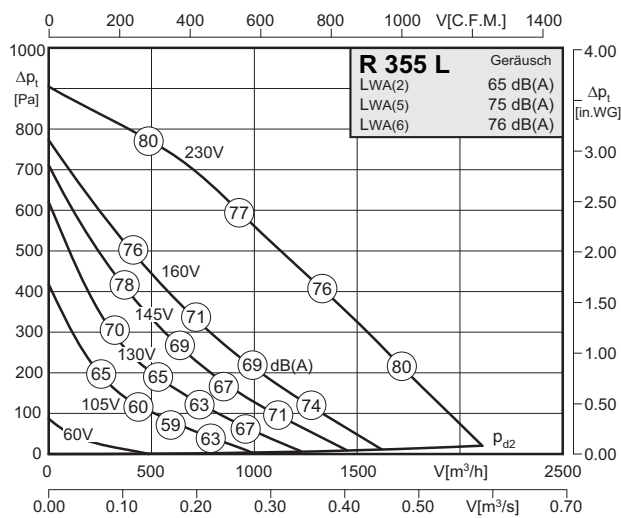
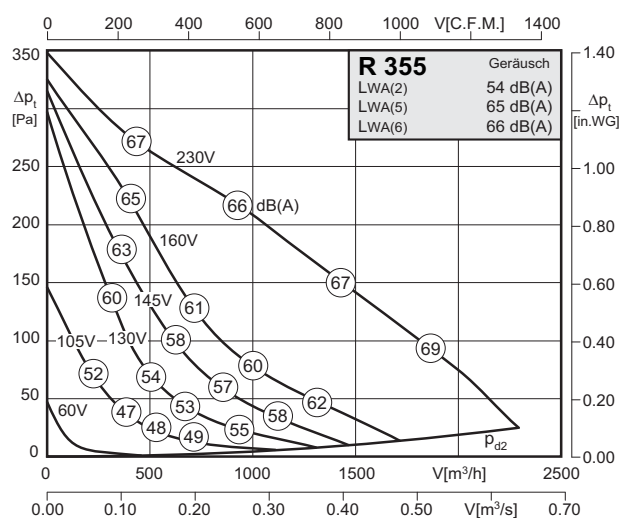

Typ / Type: R 355		Art.-Nr. / Art.-No.: F00-35510	
U	230V (50Hz)	Δp_{fa} min	- Pa
P ₁	0.26 kW	ΔI	11 %
I _N	1.15 A	I _A / I _N	1.9
n	1290 min ⁻¹		IP54
C _{400V}	5 μ F		01.024
t _R	45 °C		13.5 kg

Typ / Type: R 355 L		Art.-Nr. / Art.-No.: F00-35511	
U	230V (50Hz)	Δp_{fa} min	- Pa
P ₁	0.61 kW	ΔI	8 %
I _N	2.60 A	I _A / I _N	1.8
n	2340 min ⁻¹		IP54
C _{400V}	12 μ F		01.024
t _R	50 °C		14.0 kg

Geräusche / Sound levels:

LWArel A-bewertet bei V=0,5*Vmax LWArel A-weighted at V=0,5*Vmax		fM [Hz]						
		125	250	500	1K	2K	4K	8K
LWA2 [dB(A)]	Gehäuse / casing	48	49	48	45	40	36	24
LWA5 [dB(A)]	Ansaugseite / inlet side	53	60	60	58	54	51	41
LWA6 [dB(A)]	Ausblasseite / outlet side	53	56	61	60	59	55	46

LWArel A-bewertet bei V=0,5*Vmax LWArel A-weighted at V=0,5*Vmax		fM [Hz]						
		125	250	500	1K	2K	4K	8K
LWA2 [dB(A)]	Gehäuse / casing	46	56	57	61	58	55	40
LWA5 [dB(A)]	Ansaugseite / inlet side	56	69	69	70	65	63	55
LWA6 [dB(A)]	Ausblasseite / outlet side	57	60	69	72	70	66	60

Schaltbild / Wiring diagram:

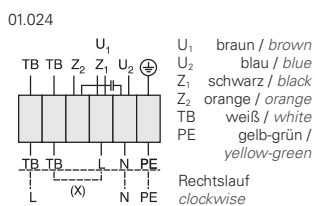

Maße / Dimensions:

(alle Maße in mm / all dimensions in mm)

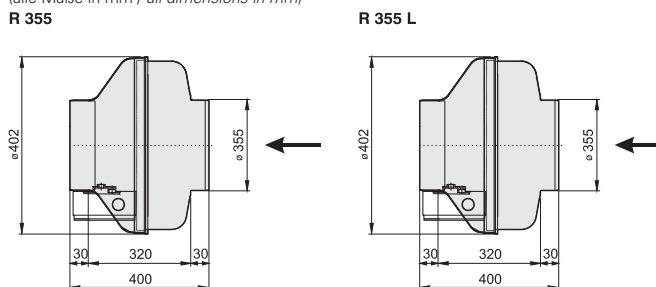

Zubehör / Accessories:

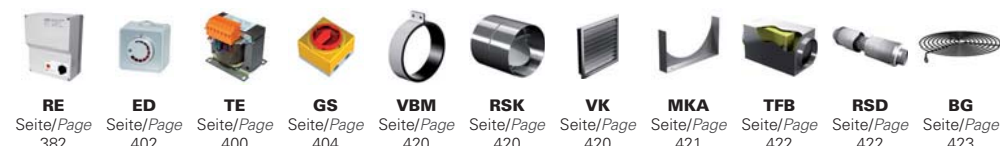



- Gehäuse aus verzinktem Stahlblech
 - in allen Einbaulagen einsetzbar
 - einfacher elektrischer Anschluss durch außenliegenden Klemmkasten (IP54)
 - Isolierstoffklasse F
 - Motorschutz durch Thermokontakte
 - transformatorisch und elektronisch 100% stufenlos steuerbar
- casing made of galvanized sheet steel
 - easy installation in any position
 - easy electrical connection via IP54 terminal box
 - insulation class F
 - motor protection by thermal contacts
 - speed is 100% infinitely variable using auto transformers or electronic control

Technische Daten / Technical Data:

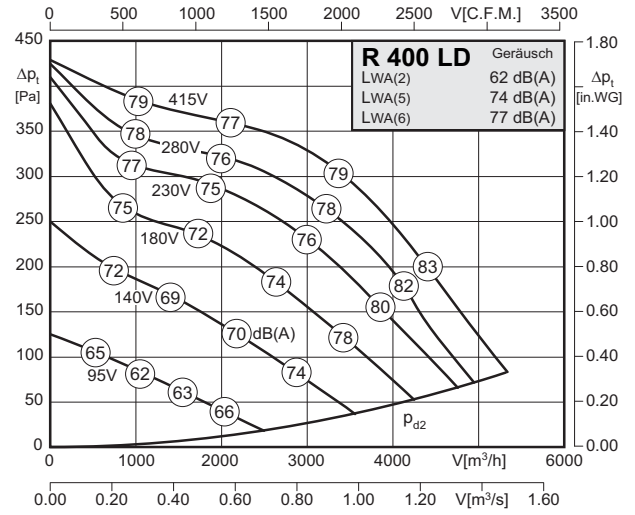
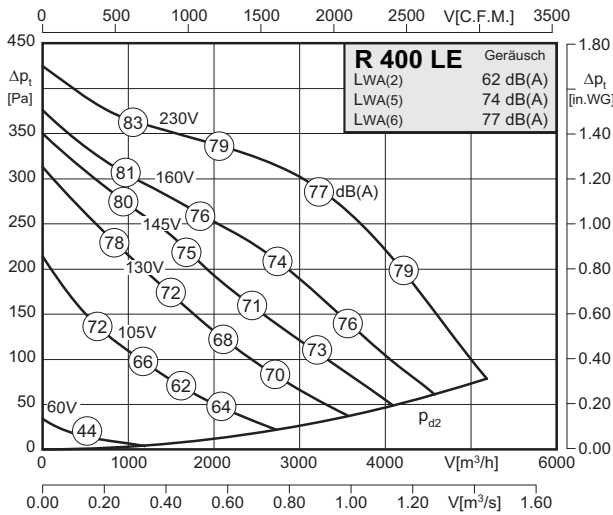

Typ / Type: R 400 LE		Art.-Nr. / Art.-No.: F00-40010	
U	230V (50Hz)	Δpfa min	-- Pa
P1	0,70 kW	ΔI	22 %
IN	3.30 A	IA / IN	2.5
n	1350 min-1	▲	IP54
C400v	16 μF	★	01.024
tR	70 °C	■	31.0 kg

Typ / Type: R 400 LD		Art.-Nr. / Art.-No.: F00-40000	
U	400V (50Hz)	Δpfa min	-- Pa
P1	0,67 kW	ΔI	8 %
IN	1.55 A	IA / IN	4.8
n	1400 min-1	▲	IP54
C400v	-- μF	★	01.006
tR	70 °C	■	31.0 kg

Geräusche / Sound levels:

LWArel A-bewertet bei V=0,5*Vmax LWArel A-weighted at V=0,5*Vmax		fM [Hz]						
		125	250	500	1K	2K	4K	8K
LWA2 [dB(A)]	Gehäuse / casing	48	56	57	56	52	47	39
LWA5 [dB(A)]	Ansaugseite / inlet side	57	69	69	67	64	59	52
LWA6 [dB(A)]	Ausblasseite / outlet side	56	69	72	74	71	63	55

LWArel A-bewertet bei V=0,5*Vmax LWArel A-weighted at V=0,5*Vmax		fM [Hz]						
		125	250	500	1K	2K	4K	8K
LWA2 [dB(A)]	Gehäuse / casing	48	56	57	56	52	47	39
LWA5 [dB(A)]	Ansaugseite / inlet side	57	69	69	67	64	59	52
LWA6 [dB(A)]	Ausblasseite / outlet side	56	69	72	74	71	63	55

Schaltbild / Wiring diagram:

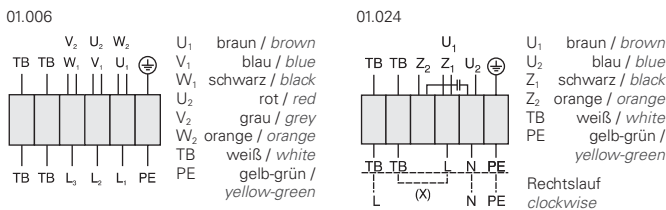

Maße / Dimensions:

(alle Maße in mm / all dimensions in mm)
 R 400 LE / LD

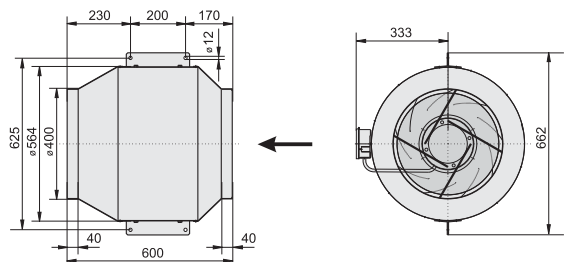

Zubehör / Accessories:

